

ZUBEHÖR

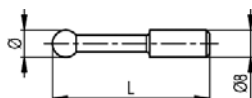

		TVM	V/V Plus	VT	M/MT
TV2S2 279 901007 010	Konus Ø 0-15 mm	•			
TV2S3 279 901007 003	Konus Ø 13-20.5 mm	•			
TV2S4 509 05 20 0001	Konus Ø 17-24.5 mm	•			
TV2S5 279 901007 005	Konus Ø 23-30.5 mm	•			
TV2S6 279 901007 006	Konus Ø 26-35.5 mm	•			
TV2S7 279 901007 007	Konus Ø 32-39 mm	•			
TV2S8 279 901007 008	Konus Ø 36-45 mm	•			
TV2S9 279 901007 009	Konus Ø 41-50 mm	•			
TV2S10 279 901007 010	Konus Ø 46-55 mm	•			
TV2S11 279 901007 011	Konus Ø 51-60 mm	•			
TVM2.9 509 05 20 0001	Kugel-Messeinsatz Ø 0.5 mm	•			
TVM2.8 509 05 20 0003	Kugel-Messeinsatz Ø 1 mm	•			
TVM2.4 509 05 20 0009	Kugel-Messeinsatz Ø 2 mm	•			
TVM2.3 509 05 20 0014	Kugel-Messeinsatz Ø 3 mm	•			
TVM2.2 509 05 20 0025	Kugel-Messeinsatz Ø 4 mm	•			
TVM2.6 509 05 20 0031	Kugel-Messeinsatz Ø 5 mm	•			
TVM2.1 509 05 20 0037	Kugel-Messeinsatz Ø 6 mm	•			
TVM2.7 509 05 20 0045	Kugel-Messeinsatz Ø 7 mm	•			
TVM2 509 05 20 0051	Kugel-Messeinsatz Ø 8 mm	•			

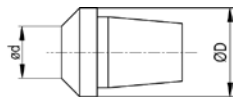

TVM



V/V Plus



VT



M/MT

ZUBEHÖR

			TVM	V/V Plus	VT	M/MT
	TVM2.5 509 05 20 0059	Zylindrischer Messeinsatz Ø 8 mm	●			
	TVM3 609 12 003	Anreissnadel	●			
	TVM1003 609 12 002	Anreissnadel für TVM1000	●			
	TV7.1 609 05 023	Abgeschrägter Messeinsatz		●		
	TV7.2 609 05 022	Kugel-Messeinsatz Ø 3 mm		●		
	TV7.3 609 05 020	Zylindrischer Messeinsatz Ø 2 mm		●		
	TV7.4 609 05 019	Zylindrischer Messeinsatz Ø 5 mm		●		
	TVA9.1 509 05 20 0011	Balliger Messeinsatz M3-M16		●	●	●
	TVA9.2 509 05 20 0029	Balliger Messeinsatz M6-M48		●	●	●
	TVA9.3 509 05 20 0062	Balliger Messeinsatz M12-M150		●	●	●
	TA-MI-111 509 05 20 0078	Messeinsatz mit Hartmetall-Kugel Ø 1 mm		●	●	●
	TA-MI-110 509 05 20 0077	Messeinsatz mit Hartmetall-Kugel Ø 2 mm		●	●	●
	TA-MI-104 509 05 20 0080	Messeinsatz mit Hartmetall-Kugel Ø 2 mm		●	●	●
	TA-MI-103 509 05 20 0076	Messeinsatz mit Rubin-Kugel Ø 2 mm		●	●	●

ZUBEHÖR

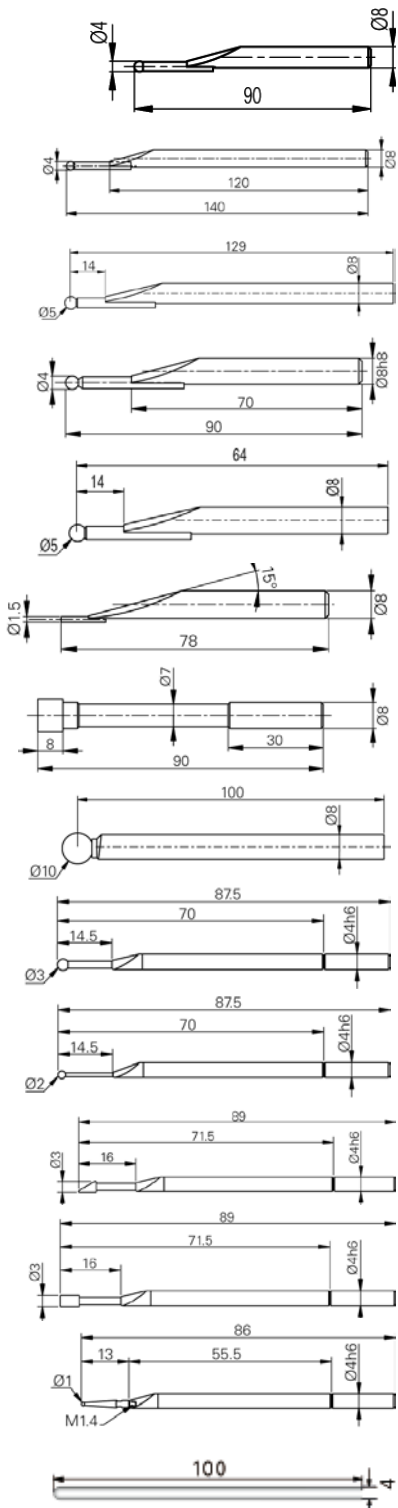

		TVM	V/V Plus	VT	M/MT
TA-MI-102 509 05 20 0075	Messeinsatz mit Hartmetall-Kugel Ø 4 mm		•	•	•
TA-MI-105 509 05 20 0079	Messeinsatz mit Hartmetall-Kugel Ø 4 mm		•	•	•
TA-MI-106 279 918011 004	Messeinsatz mit Rubin-Kugel Ø 5 mm		•	•	•
TA-MI-101 509 05 20 0074	Messeinsatz mit Rubin-Kugel Ø 4 mm		•	•	
TA-MI-119 SP279 918011 005	Messeinsatz mit Rubin-Kugel Ø 5 mm				•
TA-MI-107 509 05 20 0081	Zylindrischer Messeinsatz Ø 1.5 mm		•	•	•
TA-MI-112 509 05 20 0082	Messeinsatz mit Parallel-Messflächen		•	•	•
TA-MI-108 279 918011 002	Messeinsatz mit Rubin-Kugel Ø 10 mm		•	•	•
TA-MI-109 279 918011 003	Messeinsatz mit Rubin-Kugel Ø 3 mm		•	•	•
V-50.9 279 918011 001	Messeinsatz mit Rubin-Kugel Ø 2 mm		•	•	•
V-50.10 279 918007 001	Abgeschrägter Messeinsatz		•	•	•
V-50.11 279 918013 001	Balliger Messeinsatz Ø 3 x 5 mm		•	•	•
V-50.12 279 918012 001	Kugel-Messeinsatz Ø 1 mm mit Halter		•	•	•
TA-MI-114 506 22 20 0063	Stift, 1 halbkugelförmige und 1 flache Messfläche		•	•	•



TVM



V/V Plus



VT







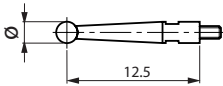
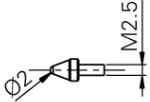
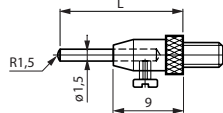
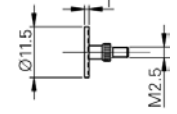
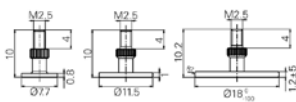
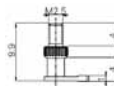
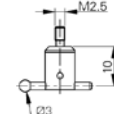
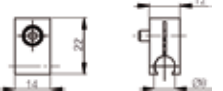
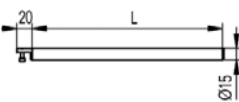

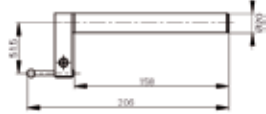
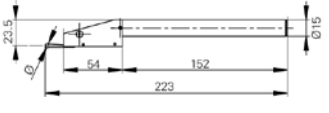

M/MT

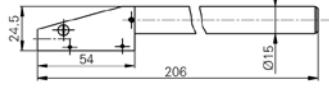
ZUBEHÖR

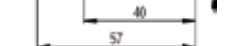
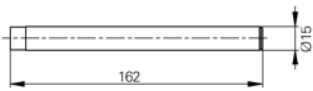
		TVM	V/V Plus	VT	M/MT
	<p>TA-MI-115 279 901001 001</p> <p>Fühlhebelmesseinsatz M1.4 mit Kugel Ø 1 mm</p>		•	•	•
	<p>TA-MI-116 279 901001 002</p> <p>Fühlhebelmesseinsatz M1.4 mit Kugel Ø 2 mm</p>		•	•	•
	<p>TA-MI-117 279 901001 003</p> <p>Fühlhebelmesseinsatz M1.4 mit Kugel Ø 3 mm</p>		•	•	•
	<p>V-50.4 279 918010 001</p> <p>Messeinsatz M2.5 mit kugelförmiger Messfläche</p>		•	•	•
					
	<p>TA-MI-118 279 901003 001</p> <p>Messeinsatz M2.5 mit 4 wechselbaren Stiften L=16/26/36/46 mm</p>		•	•	•
					
	<p>V-50.2.1 279 918005 002</p> <p>Diskförmiger Messeinsatz M2.5, Ø 7.7 mm</p>		•	•	•
	<p>V-50.2.2 279 918005 003</p> <p>Diskförmiger Messeinsatz M2.5, Ø 11.5 mm</p>		•	•	•
					
	<p>V-50.2.3 279 918005 004</p> <p>Diskförmiger Messeinsatz M2.5, Ø 18 mm</p>		•	•	•
	<p>V-50.2 279 918005 001</p> <p>Satz mit 3 Diskusförmigen Messeinsätzen M2.5</p>		•	•	•
					
	<p>V-50.3 279 918008 001</p> <p>L-förmiger Messeinsatz M2.5</p>		•	•	•
					
	<p>V-50.1 279 918009 001</p> <p>Messeinsatz M2.5 mit Rubin-Kugel Ø 3 mm</p>		•	•	•
					
	<p>TVM1.1 502 02 10 0015</p> <p>Aufnahme-Bride Ø 8 mm</p>	•			
					
	<p>TVM1 612 11 007</p> <p>Standard Messeinsatz-Halter für TVM, L=154 mm</p>	•			
	<p>TVM1/L250 612 11 061</p> <p>Messeinsatz-Halter, L=250 mm</p>	•			
	<p>TVM1/L300 612 11 062</p> <p>Messeinsatz-Halter, L=300 mm</p>	•			
					
	<p>TVM1/L350 612 11 063</p> <p>Messeinsatz-Halter, L=350 mm</p>	•			

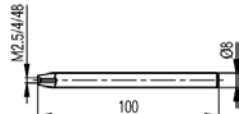
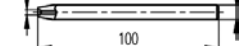
ZUBEHÖR

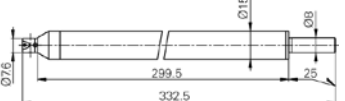
			TVM	V/V Plus	VT	M/MT
	TVM1/1.1/2 609 05 061	Messeinsatz mit Halter (TVM1 + 1.1 + 2)	•			
	TVA1 612 11 028	Messeinsatz mit Halter für TVM1000	•			
	TVM4 609 05 074	Umkehrtaster Ø4 mm	•			
	TVM4.1/4.2 609 05 075	Umkehrtaster Ø2 mm	•			
	TVM4.1 612 11 030	Halter für Umkehrtaster	•			
	TVM4.2 609 05 021	Messeinsatz Ø2 mm für Umkehrtaster	•			
	TVM4.3 609 05 024	Messeinsatz Ø4 mm für Umkehrtaster	•			
	TVM5.1 609 05 054	Konushalter	•			
	TVM5 709 05 054	Satz Zentrierkonen mit Halter (TV2S2/3/4/5 + TVMS2)	•			
	TVM6 512 11 20 0018	Halter Ø8 mm für Messeinsätze M2.5	•			
	TVM6E 512 11 20 0019	Halter Ø8 mm für Messeinsätze 4-48	•			
	TA-IH-101 612 11 045	Messeinsatz-Halter M2.5		•	•	•
	TA-IH-103 612 11 047	Messeinsatz-Halter 4-48		•	•	•
	TA-IH-102 612 11 046	Messeinsatz-Halter M2.5		•	•	•



TVM



V/V Plus











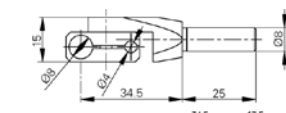
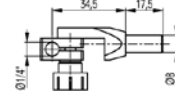

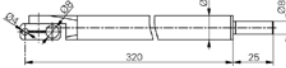
VT



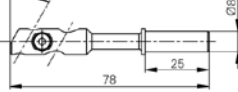

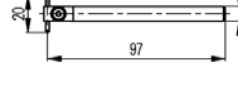





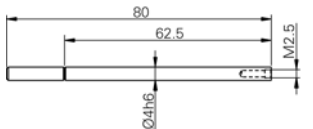
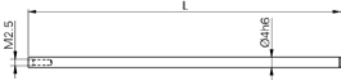

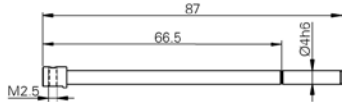
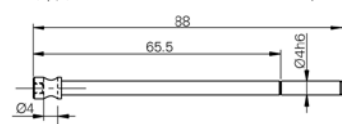
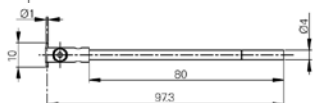
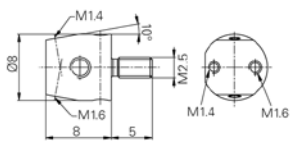
M/MT

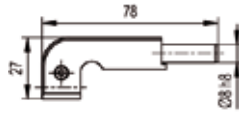
ZUBEHÖR

			TVM	V/V Plus	VT	M/MT
	TA-IH-104 612 11 053	Orientabler Messeinsatz-Halter Ø 4 und 8 mm		•	•	•
	V-2E 612 11 023	Orientabler Messeinsatz-Halter Ø 1/4 "		•		
	TA-IH-105 612 11 051	Orientabler Messeinsatz-Halter Ø 4 und 8 mm		•	•	•
	V-2E/D1/4/L150 612 11 013	Orientabler Messeinsatz-Halter Ø 1/4"		•	•	•
	TA-IH-106 612 11 039	Orientabler Messeinsatz-Halter Ø 4 und 8 mm		•	•	•
	TA-IH-107 612 11 055	Messeinsatz-Halter 90°, Ø 8 mm		•	•	•
	TA-IH-108 612 11 052	Messeinsatz-Halter 90°, Ø 8 mm		•	•	•
	TA-IH-109 612 11 054	Messeinsatz-Halter 90°, Ø 4 mm		•	•	•
	TA-IH-110 279 918103 001	Messeinsatz-Halter 90°, Ø 4 mm		•	•	•
	V-4 612 11 011	Messeinsatz-Halter 30°, Ø 4 mm		•	•	•
	TA-IH-111 612 11 041	Messeinsatz-Halter 90°, Ø 4 mm, L=150 mm		•	•	•
	TA-IH-112 612 11 042	Messeinsatz-Halter 90°, Ø 4 mm, L=300 mm		•	•	•
	TVA4 609 05 007	Messeinsatz mit Stift Ø 2 x 20 mm		•	•	•
	TA-IH-113 612 11 043	Messeinsatz mit Stift Ø 2 x 20 mm, L=200 mm		•	•	•
	TA-IH-114 612 11 044	Messeinsatz mit Stift Ø 2 x 20 mm, L=300 mm		•	•	•

ZUBEHÖR

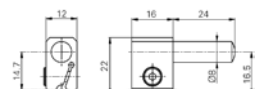
			TVM	V/V Plus	VT	M/MT
	V-50.6 279 918002 002	Messeinsatz-Halter M2.5		•	•	•
	V-50.5 279 918002 001	Messeinsatz-Halter M2.5, L=124 mm		•	•	•
	TA-IH-115 279 918002 003	Messeinsatz-Halter M2.5, L=200 mm		•	•	•
	V-50.7 279 918001 002	Messeinsatz-Halter 90°, M2.5		•	•	•
	V-50.8 279 918001 001	Messeinsatz-Halter 90°, Ø 4 mm		•	•	•
	TA-IH-116 279 918001 003	Messeinsatz mit Stift, Ø 1 x 10 mm		•	•	•
	TA-IH-117 512 11 20 0012	Halter für Messeinsätze M2.5, M1.6, M1.4		•	•	•
	TA-IH-118 512 11 20 0013	Halter für Messeinsätze 4-48, M1.6, M1.4		•	•	•
	TA-IH-126 612 07 006	Halter für Rechtwinkligkeitstaster			•	•
	TA-MS-101 276 940001 001	Rechtwinkligkeitstaster für VT/M/MT 300/600			•	•
	TA-MS-102 276 940001 002	Rechtwinkligkeitstaster für VT/M/MT 1000			•	•
	TA-MS-103 609 02 020	Rechtwinkligkeitstaster für VT1500			•	
	TA-MS-104 609 02 021	Rechtwinkligkeitstaster für VT2000			•	
	TVM1010 603 12 005	Reduktionshülse Ø 20 / 15 mm (TVM1000)	•			
	V-5 612 11 012	Reduktion Ø 8 / 4 mm		•	•	•



TVM



V/V Plus



VT





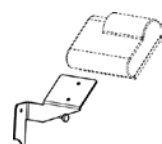
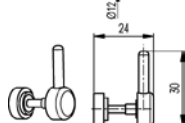
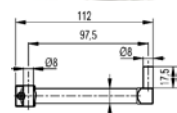
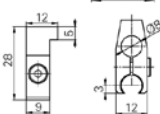
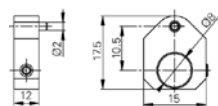

M/MT

ZUBEHÖR



		TVM	V/V Plus	VT	M/MT
TA-AD-101 603 11 001	Positionierhalter für Messeinsatz VT/MT			•	•
TA-AD-102 603 11 002	Positionierhalter für Messeinsatz V+		•		
TA-AD-104 SP612 05 014 01	Verstellbare Anzeige-Auflage für VT/MT			•	•
V-7/H100 612 11 025	Verlängerung für Messeinsatz-Halter 100 mm		•		
V-20 606 00 029	Schnellklemmung für Messeinsatz-Halter		•		
V-32 612 06 001	Druckerhalter für V+		•		
V-32/SP SP612 06 001 01	Druckerhalter für VT/MT (nur ab Werk)			•	•
TA-SE-101 605 01 007	Zubehörsatz «Macro» (16 Stk.)		•	•	•
TA-SE-102 605 01 008	Zubehörsatz «Micro» (20 Stk.)		•	•	•
TA-MG-103 609 01 026	Einstellehre		•		
TA-MG-101 609 01 024	Einstellehre 25 mm			•	•
TA-MG-102 609 01 025	Einstellehre 1"			•	•
V-60 612 12 045	Zubehör-Ablagefach		•	•	•
V-50.13 290 918001 001	Schlüssel für Fühlhebelmesseinsatz		•	•	•

ZUBEHÖR

			TVM	V/V Plus	VT	M/MT
	V-50.15 290 000911 005	Inbusschlüssel 2.5 mm		•		
	TA-TO-001 290 000911 009	Inbusschlüssel 5 mm			•	•
	TA-TO-002 290 920001 001	Sechskant-Schraubendreher 2 mm		•	•	•
	LABC-30.3 3708 0002	Stift für Touchscreen			•	•
	TVM.HO300 505 05 10 0009	Schutzhaube für TVM301, TC401	•			
	TVM.HO600 505 05 10 0011	Schutzhaube für TVM601, TC601	•			
	TVM.HO1000 505 05 10 0013	Schutzhaube für TVM1000	•			
	V.HO300 505 05 10 0020	Schutzhaube für V300		•		
	V.HO600 505 05 10 0021	Schutzhaube für V600		•		
	V.HO1000 505 05 10 0022	Schutzhaube für V1000		•		
	TA-TO-109 505 05 10 0005	Schutzhaube für VT/M/MT 300			•	•
	TA-TO-110 505 05 10 0006	Schutzhaube für VT/M/MT 600			•	•
	TA-TO-111 505 05 10 0007	Schutzhaube für VT/M/MT 1000			•	•
	TA-TO-112 505 05 10 0008	Schutzhaube für VT 1500			•	
TA-TO-113 505 05 10 0037	Schutzhaube für VT 2000			•		



TVM



V/V Plus



VT



M/MT

ZUBEHÖR

			TVM	V/V Plus	VT	M/MT
	BAT-TVM.OPTO 3705 0002	Batterie	•			
	TELMA31 3706 0002	Fusspedal		•		
	TA-EL-101 3706 0006	Fusspedal (VT/MT)			•	•
	LABC-40 356 0010	Laser-Drucker (USB)			•	•
	TA-EL-030 356 0016	Tintenstrahl-Drucker (USB)			•	•
	V-30 356 0007	Drucker (RS232)		•	•	•
	TVM.O-PC/AT.9P 333 9 0003	Kabel Opto-PC / AT 9 P/W 2 m	•			
	V-31 333 0 0003	Kabel für RS232-Drucker		•		
	CABL.RS.1/1-9P 332 01 0001	Kabel RS232 m/w, 1.8 m (VT/M/MT: Drucker & V / V Plus / H: PC)		•	•	•
	TA-EL-110 332 01 0012	Kabel RS232 w/w, 1.8 m (PC)			•	•
	TA-EL-013 332 02 0001	Verbindungskabel, USB A-B, L=1.8 m			•	•
	TA-EL-011 358 0006	USB-RS232 Konverter	•	•	•	•
	TA-EL-131 334 0020	Universal Ladegerät, 9 V (ohne Kabel)		•		

ZUBEHÖR

			TVM	V/V Plus	VT	M/MT
	TA-EL-130 357 0100	Universal Ladegerät, 28 V (ohne Kabel)			•	•
	TA-EL-001 332 10 0011	Netzkabel, 2-polig, Europa		•	•	•
	TA-EL-002 332 10 0013	Netzkabel, 2-polig, USA/Japan		•	•	•
	TA-EL-003 332 10 0016	Netzkabel, 2-polig, Australien		•	•	•
	TA-EL-004 332 10 0014	Netzkabel, 2-polig, UK		•	•	•
	TA-EL-005 616 20 003	Netzkabel, 2-polig, Korea		•	•	•
	V-30.7 788 000001 001	Papierrollen (5 Stk.)		•		
	TA-EL-120 609 50 005	Temperaturkompensations-System			•	
	TA-EL-121 616 70 001	Drahtloses Kommunikations-System «Wi-Fi»			•	•
	TA-EL-122 616 70 002	Drahtloses Kommunikations-System «Bluetooth»			•	•
	TA-EL-123 609 50 006	Temperaturkompensations-System «Wi-Fi»			•	
	TA-EL-124 609 50 007	Temperaturkompensations-System «Bluetooth»			•	
	TA-EL-140 358 0008	USB memory stick			•	•
	TA-SW-001 394 1 0050	Software für Datenübertragung WinDDE	•	•	•	•



TVM



V/V Plus



VT



M/MT

ZUBEHÖR



TA-SE-101
605 01 007

Zubehörsatz Macro (16 Stück):

- TA-MI-105 Messeinsatz mit Hartmetall-Kugel Ø4 mm, L=140 mm
- TA-MI-110 Messeinsatz mit Hartmetall-Kugel Ø2 mm, L=80 mm
- TA-MI-107 Zylindrischer Messeinsatz Ø1.5 mm, L=78 mm
- TA-IH-105 Orientabler Messeinsatz-Halter Ø4 und Ø8 mm, L=150 mm
- TA-IH-109 Messeinsatz-Halter 90°, Ø4 mm
- TVA4 Messeinsatz-Halter mit Stift Ø 2 x 20 mm
- TA-IH-101 Messeinsatz-Halter M2.5, L=103 mm
- V-50.5 Messeinsatz-Halter M2.5, L=124 mm
- TA-IH-115 Messeinsatz-Halter M2.5, L=200 mm
- V-50.4 Messeinsatz M2.5 mit kugelförmiger Messfläche
- V-50.2.3 Diskförmiger Messeinsatz M2.5, Ø18 mm
- TA-MI-115 Fühlhebelmesseinsatz M1.4 mit Kugel Ø1 mm, L=12,5 mm
- TA-MI-116 Fühlhebelmesseinsatz M1.4 mit Kugel Ø2 mm, L=12,5 mm
- TA-MI-117 Fühlhebelmesseinsatz M1.4 mit Kugel Ø3 mm, L=12,5 mm
- V-50.13 Schlüssel für Fühlhebelmesseinsatz
- V-50.15 Inbusschlüssel 2.5 mm

TVM
V/V Plus
VT
M/MT

• • •



TA-SE-102
605 01 008

Zubehörsatz Micro (20 Stück):

- V-50.4 Messeinsatz M2.5 mit kugelförmiger Messfläche
- TA-MI-118 Messeinsatz M2.5 mit 4 wechselbaren Stiften
- V-50.2.1 Diskförmiger Messeinsatz M2.5, Ø7.7 mm
- V-50.2.2 Diskförmiger Messeinsatz M2.5, Ø11.5 mm
- V-50.3 L-förmiger Messeinsatz M2.5
- TA-MI-115 Fühlhebelmesseinsatz M1.4 mit Kugel Ø1 mm, L=12,5 mm
- TA-MI-116 Fühlhebelmesseinsatz M1.4 mit Kugel Ø2 mm, L=12,5 mm
- TA-MI-117 Fühlhebelmesseinsatz M1.4 mit Kugel Ø3 mm, L=12,5 mm
- TA-IH-117 Halter für Messeinsätze M2.5, M1.6, M1.4
- V-50.6 Messeinsatz-Halter M2.5
- V-50.8 Messeinsatz-Halter 90°, Ø4 mm
- TA-IH-116 Messeinsatz mit Stift, Ø1 x 10 mm, L=80 mm
- V-50.9 Messeinsatz mit Rubin-Kugel Ø2 mm, L=88 mm
- V-50.12 Kugel-Messeinsatz Ø1 mm mit Halter, L=86 mm
- V-50.10 Abgeschrägter Messeinsatz
- V-5 Reduktion Ø 8 / 4 mm
- TA-IH-104 Orientabler Messeinsatz-Halter Ø4 und Ø8 mm
- V-50.13 Schlüssel für Fühlhebelmesseinsatz
- TA-TO-003 Inbusschlüssel 1.5 mm
- V-50.15 Inbusschlüssel 2.5 mm

• • •